



INSTALLATION INSTRUCTIONS

Accessory

**BED EXTENDER
P/N 08L26-SJC-100**

Application

2010 RIDGELINE

Publications No.

All 42118

Issue Date

AUG 2009

PARTS LIST

Left tube

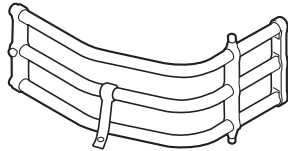

Right tube (with label)

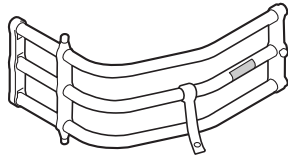

3 Center tubes

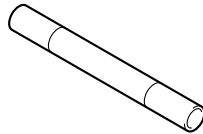

6 Threaded wedge



6 Non-threaded wedge



6 Torx screws



2 Snap-screws



2 Washers



2 Fenderwell nuts



6 Hex bolts



Left latch



Right latch

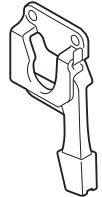

Left bracket
(with latch)

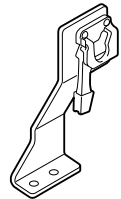

Right bracket
(with latch)

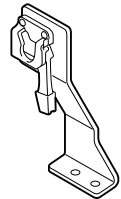

Template



Owner's Manual

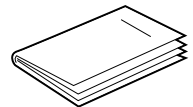

TOOLS AND SUPPLIES REQUIRED

Ratchet

10 mm Socket

T-20 and T-50 Torx wrench

Tape measure

Drill

3 mm and 8 mm Drill bit

Center punch

File

Eye protection (face shield, safety goggles, etc.)

Felt-tip pen

Awl

3 mm Allen wrench

INSTALLATION

Customer Information: The information in this installation instruction is intended for use only by skilled technicians who have the proper tools, equipment, and training to correctly and safely add equipment to your vehicle. These procedures should not be attempted by “do-it-yourselfers.”

NOTE: Be careful not to damage the body finish.

1. Insert the three center tubes into the left tube.

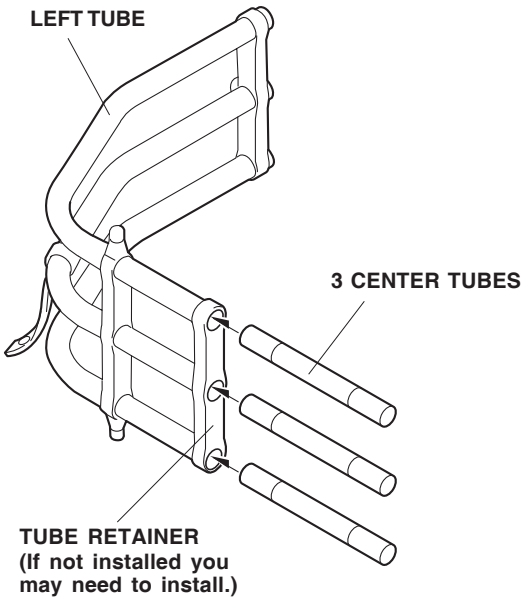

2. Align the non-threaded wedge with the threaded wedge at each of the three joints between the left and center tubes, then install one Torx screw through each pair.

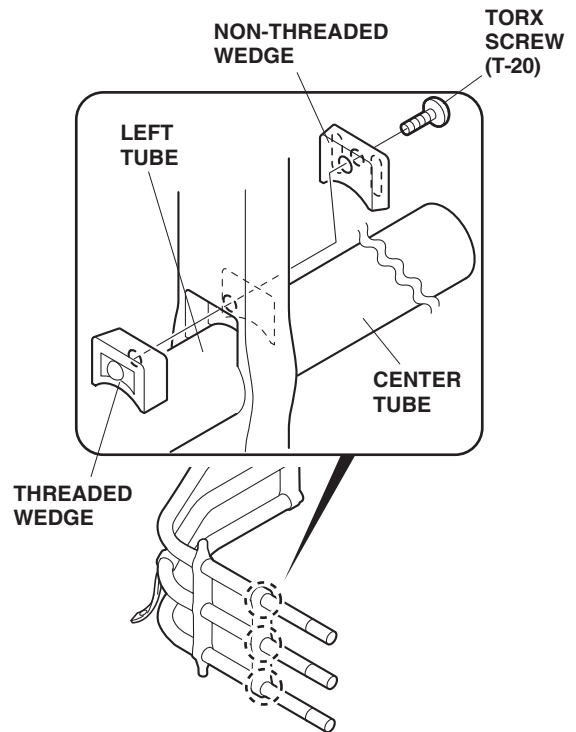

3. Insert the right tube into the three center tubes.

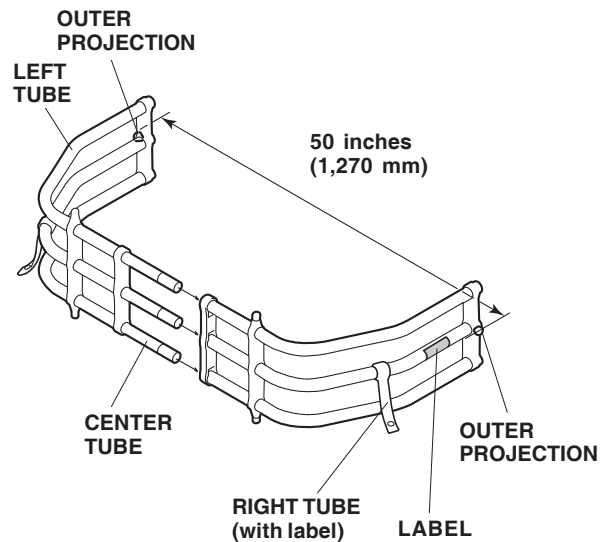

4. Adjust the tubes so that the distance between the outer projections on the ends of the right and left tubes are 50 inches (1,270 mm).

- Align the non-threaded wedge with the threaded wedge at each of the three joints between the right and center tubes, then install one Torx screw through each pair.

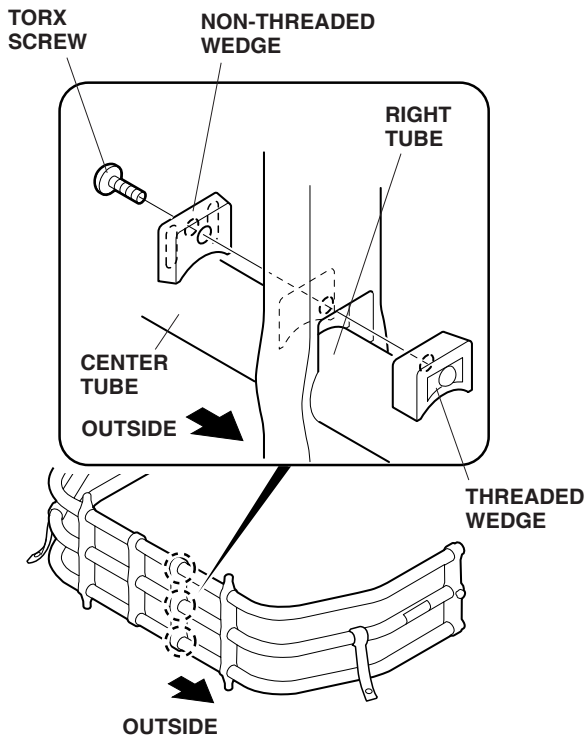

- Using an awl, push through each hole to remove the hole seal. Install the left latch to the left side bed liner with three hex bolts.

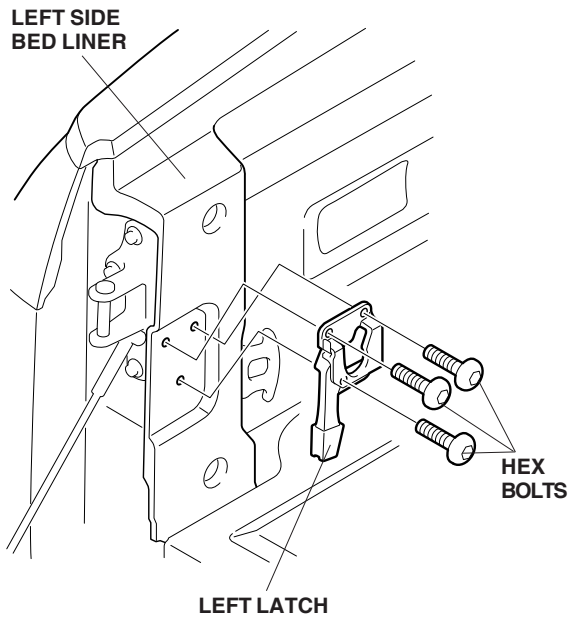

- Remove the left front lower tie-down hook (two Torx bolts).

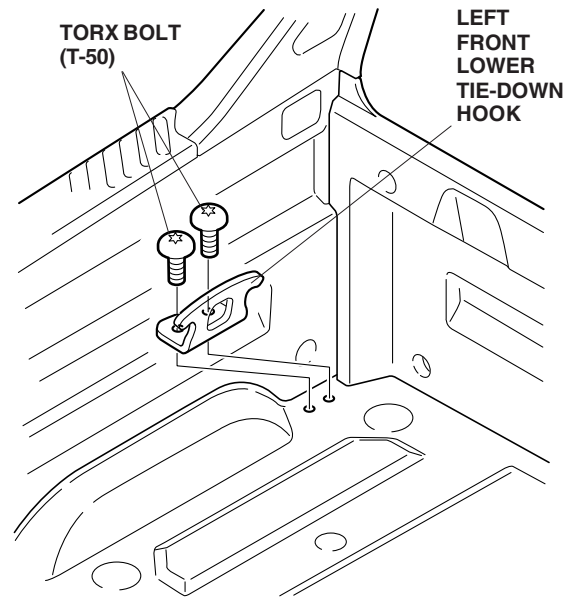

- Install the left bracket and the left front lower tie-down hook using the two Torx bolts you removed.

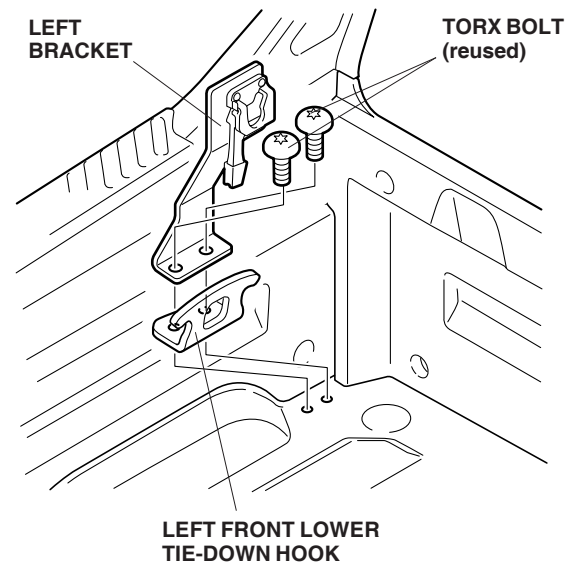

- Position the template on the top left side of the tailgate at the latch area. Using a center punch, mark the tailgate through the hole in the template.

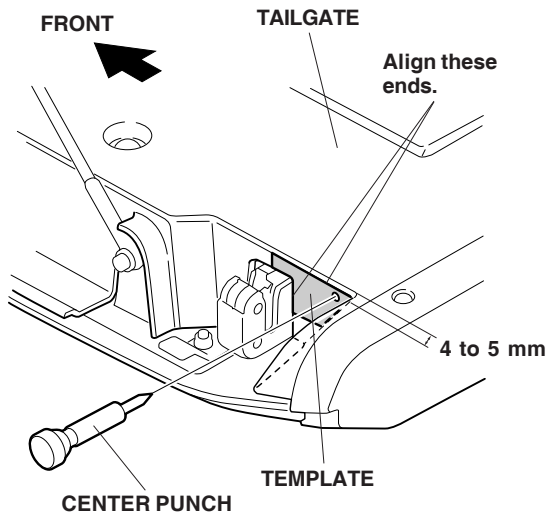

- Using the felt-tip pen and the center punch, mark the right side of the tailgate at the center of the triangle area.

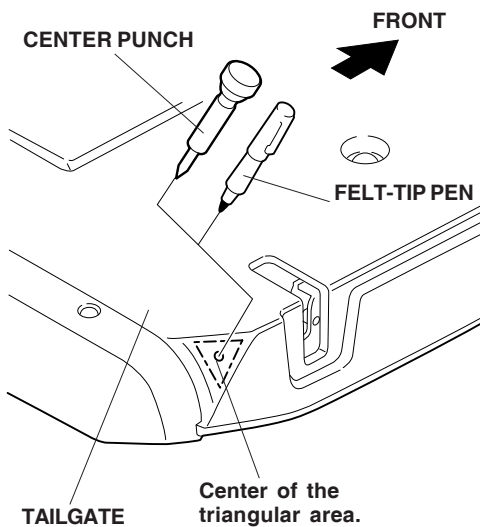

- While wearing eye protection, drill an 8 mm hole through the center-punched mark on the left side of the tailgate. Use a drill stop to avoid drilling through the inner panel. First drill with a 3 mm drill bit, and finish with an 8 mm drill bit. After drilling, remove all burrs from the edges of the hole with a file.

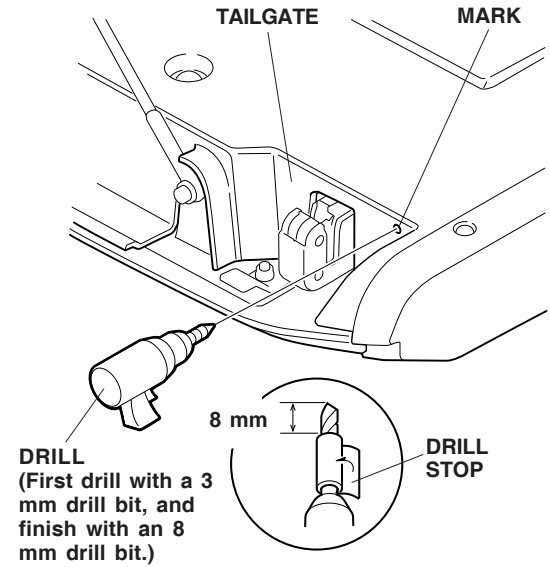

- Press one fenderwell nut into the drilled hole in the tailgate.

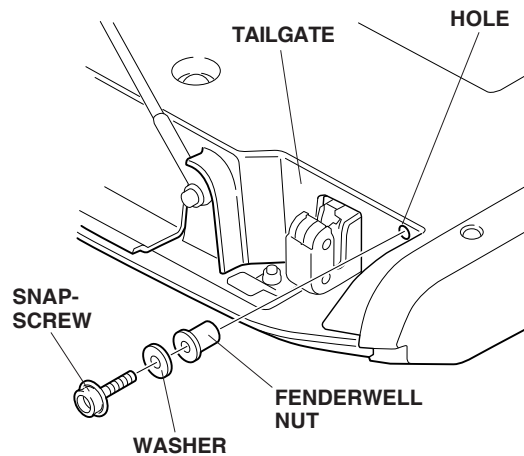

- With its washer in place, securely tighten one snap-screw into the fenderwell nut.
- Repeat steps 11 thru 13 to drill and install a fenderwell nut and snap-screw on the right side of the tailgate.
- Install the bed extender as described in the owner's manual supplied.